

Absorption Gas Refrigerator Manual

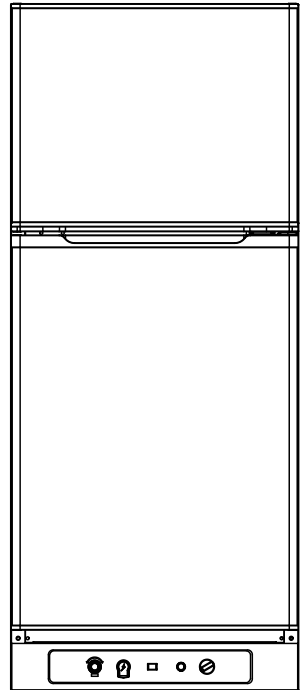
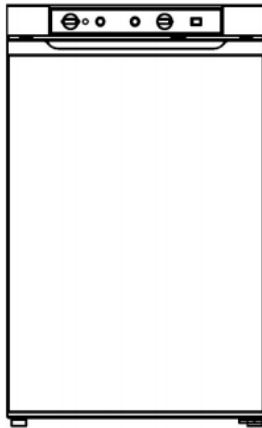

OWNER'S MANUAL

Improper installation, adjustment, alteration, service or maintenance can cause injury or property damage. Refer to this manual. For assistance or additional information consult a qualified installer, service agency or the gas supplier.

This product can produce Carbon Monoxide. Carbon Monoxide has no odour and can kill you. The burner and flue system must be kept clean. See owner's manual for cleaning instructions.

FOR YOUR SAFETY:

- . Do not store or use gasoline or other flammable vapors and liquids in the vicinity of this or any other appliance.

IF YOU SMELL GAS:

- . Open windows.
- . Exting any open flame.
- . Do not touch electrical switches.
- . Immediately turn off gas supply and call your gas supplier.

Installation Instructions:

- . The installation of the appliance must conform with local codes or, in the absence of local national Fuel Gas Code.

Pressure range of pressure reducing valve:

- . 28-30mbar. This product is suitable for 28-30mbar inlet pressure, so the range of pressure reducing valve should meet 28-30mbar.
- . If the refrigerator is tilted more than 3 degrees in the left and right directions, it will affect the performance of the product.
- . If the product has DC12V function, only DC12V can be used, not DC power supply with higher voltage, because if DC24V power supply is used, the heating tube will be burnt directly, which will make the product not work.

TABLE OF CONTENTS

INTRODUCTION.....	1
SAFETY INSTRUCTIONS.....	1
TRANSIT DAMAGE.....	1
IMPORTANT SAFETY PRECAUTIONS.....	2
Warning.....	3
Safety awareness.....	4
CAUTION.....	5
INSTALLATION INSTRUCTIONS.....	8
LEVELLING AND VENTILATION.....	8
GAS CONNECTION.....	9
Turning On The Refrigerator.....	10
Turning Off The Refrigerator.....	10
MAINTENANCE.....	10
Cleaning the burner.....	10
Inside Lighting.....	11
LPG powered Absorption-Diffusion refrigerators SAFETY AWARENESS.....	11
User instruction of Electric refrigerator and Gas refrigerator	12
PART A Installation and operation instructions for 220V-240V.....	12
PART A Installation and operation instructions for DC12V.....	13
PART A Installation and operation instructions of LPG.....	13
Battery ignition.....	15
Instructions of thermostat (An optional component and its use).....	18
PART B Care and maintenance for electricity powered refrigerators.....	18
PART B Care and maintenance for LPG burner.....	19
Correct operation of refrigerators.	20
Clean brush.....	21
Reasons for not cooling and corresponding remedies(Should be done by a qualified service man).....	21
Reasons for odor of gas and relevant solutions.....	22
TROUBLESHOOTING.....	23

INTRODUCTION

Thank you for purchasing our gas refrigerator. This unit is designed to improve your living and entertaining comfort. The absorption system is totally silent that uses no compressors or fans. The refrigerator is ideal for installation in homes, farms, Cottages, chalets or similar. With its silent operation and unique design, you will enjoy the convenience and comfort for years to come.

Please read through these instructions carefully before operating this refrigerator. When using it, always exercise basic safety precautions.

This easy-to-use manual will guide you to getting the best use of this refrigerator.

SAFETY INSTRUCTIONS

1. Do not allow children to play with the Refrigerator, even when it is turned off;
2. Do not use store liquids such gasoline, kerosene, etc. , inside your Refrigerator, thus avoiding the risks of explosions and fire;
3. Do not store toxic materials inside your Refrigerator, as they could contaminate food items;
4. Your Refrigerator should be used only by those who have read this manual or those that have been adequately instructed by someone who has read it.
5. This appliance is not intended for use by persons (including children) with reduced physical, sensory or mental capabilities, or lack of experience and knowledge, unless they have been given supervision or instruction concerning use of the appliance by a person responsible for their safety. Children should be supervised to ensure that they do not play with the appliance.
6. If the supply cord is damaged, it must be replaced by the manufacturer or its service agent or a similarly qualified person in order to avoid a hazard.
7. These appliances use flammable insulation blowing gas, please dispose the appliance according to the local regulation.

TRANSIT DAMAGE

Inspect the refrigerator for damage. Transit damage must be reported to whoever is responsible for delivery not later than seven days after the refrigerator was delivered.

Operating in excess of these specifications can damage the refrigerator's electrical circuit, related components and voids the refrigerator's warranty.

IMPORTANT SAFETY PRECAUTIONS

Before you use your absorption refrigerator, please read this instruction manual carefully.

NEVER install gas appliances in unventilated (air tight) structures or sleeping rooms. Gas refrigerators consume air (oxygen) when operated on gas power. When used in any inside area, provide a fresh air opening of at least 3 square inches (20mm). Please note that an exterior flue is not required with "vent-less" propane appliances like gas refrigerators, but you may choose to run an insulated 2 inch (min) inside diameter vent pipe through the roof (straight up is best) or the wall (avoid 90 degree bends with 45's spaced more than two feet apart). It is recommended that a carbon monoxide detector be installed in the same room as the gas refrigerator.

NEVER install a gas appliance on carpeting or against a flammable wall.

NEVER leave your gas appliances running unattended while on vacation.

NEVER run the electrical power and gas power at the same time. Backup electrical power (220-240V AC and DC12V) operation is STANDARD equipment on the gas fridge. Should you ever run out of gas, it's very handy. Just be certain to never run both heaters at the same time. Serious damage will result to the cooling unit if you do.

Use this appliance only for its intended purpose as described in this user manual.

This absorption refrigerator must be properly installed in accordance with the installation instructions before it is used.

Never unplug you absorption refrigerator by pulling on the power cord. Always grasp the plug firmly and pull straight out from the wall outlet.

Repair or replace immediately, all electric service cords that have become frayed or otherwise damaged. Do not use a cord that shows cracks or abrasion damage along its length, the plug or the connector end.

Unplug your absorption refrigerator before cleaning or before making any repairs.

NOTE: If for any reason this product requires service, we strongly recommend that a certified technician perform the service.

Do not operate your absorption refrigerator in the presence of explosive fumes.

The power supply must be properly grounded.

WARNING:

Electrical Grounding Instructions

This appliance is equipped with a three-prong (grounding) plug for your protection against shock hazards and should be plugged directly into a properly grounded three-prong receptacle. Do not cut or remove the grounding prong from this plug.

Do not use an adapter plug or extension cord.

Do not use the unit in the immediate surroundings of a bath, shower or swimming pool.

Before discarding or storing, we recommend that you remove the door and leave the shelves in place. This will reduce the possibility of danger to children. Do not store food in absorption refrigerator if you feel the interior temperature may not be cool enough to prevent spoilage.

The sealed cooling system must not be opened, since it contains corroding chemicals under high pressure.

Check that the gas supplied to the refrigerator is at the correct pressure. Double check the pressure regulator on the gas tank and comparing to the Technical data.

Operation on back-up electrical power is recommended when in motion.

WARNING:

Provide ample ventilation, especially when sleeping. This refrigerator consumes air (oxygen). Do not use this refrigerator in unventilated structures to avoid endangering your life. Provide additional ventilation for any additional fuel-burning appliances and additional occupants.

It is highly suggested that you read this manual carefully before starting to operate our Absorption-Diffusion Double-way refrigerators.

WARNINGS:

Dear customer,

Only one type of energy is allowed to be used when it is on. It is strictly forbidden to run two power means together simultaneously. For instance, suppose your refrigerator is a two-way one, when it is powered by electricity, the other source must not be used at the same time. CAUTION: When system is running on gas, the gas cylinder as well as the burner should NEVER be in the slide way, both MUST be removed from the back of the refrigerator and be placed in another place.

Before you start to operate our product, please read the following content and follow the operation instructions listed. When confronting a problem, turn to the local distributor for help, do not handle it by yourself.

SAFETY AWARENESS:

1.The refrigerator has already been tested by the manufacturer and proved to comply with the company standard. If there is any problem, please contact us.

2.Please confirm whether the refrigerator is the one you chose and whether the energy source it uses complies with your requirement.

3.For your safety, remove all the packing materials before operating the product.

4.For your safety, do not store gasoline or any other flammable vapor and liquid in the unit. Do not store erosive materials, for example, strong acid or alkali in the unit. Do not use the above-mentioned materials nearby especially when it is on.

5.For good cooling, do not use the refrigerator in an ill-ventilated room; do not expose it to the sunshine.

6.This type of refrigerator works on heat-cooling alternation, thus it is forbidden to touch the pipes at the back in case it might cause irritating burns.

7.If the unit is equipped with a thermostat, the temperature can be regulated by the thermostat. The thermostat doesn't indicate a concrete temperature but can only adjust the temperature from a high to a low level and vice versa. Users, according to their actual situation (ambient temperature, wanted temperature and quantity of the stored items), can adjust the thermostat valve's position. We suggest that you first enquire of the distributor about the proper use of thermostat.

8.It is very important to put your refrigerator in a relatively cool, dry and well-ventilated place to avoid direct exposure to the sun. Do not put it near flammable materials such as gasoline. The ground should be firm and level. The adjustable bottom screws should directly stand on the ground in order to ensure its steadiness.

9.When moving the refrigerator, you should handle it very carefully from its bottom and use an average force to prevent the back system from being damaged.

10.Storing flowers, vaccine and drugs in the refrigerator is not an approved action. If you indeed need to store these items, ask for instructions and notices from the manufacturer.

11.Separate cooked and uncooked foods when store them. Leave some space among the foodstuff for air circulation. You'd better not put hot foods in the compartment before they cool down naturally. It is best to pack the foods with peculiar smells with plastic membrane before storing them. Glass containers as well as canned drinks are not to be placed in the freezing compartment, where a rupture or split might happen due to the strong freezing. When the cooling compartment (without a thermostat) possibly reaches a temperature below 0°C, glass-contained foods, eggs and vegetables should not be put there in order to avoid rupture and split.

12.Dust on heat-dissipating unit at the back should be cleaned periodically. Otherwise, the cooling effect may be affected. It is best to do so every 10 days or so.

13. On its initial use, do not put any items in the refrigerator. Allow the refrigerator to cool for 24 hours before loading any foods. For the first time, the volume of foodstuff should not be more than 1/3 of the total capacity. After another 24 hours, put in other foods successively. Remember to leave 1/5 of the total capacity for good cool-air circulation. During its running, do not open the doors too frequently than needed.

14. When the frost thickness in the freezing compartment exceeds 4mm, you should stop the running to defrost, or the cooling can be impaired.

15. Suppose your refrigerator has been used out and you are about to throw it away; or you want to put it aside for some period, we suggest you uninstall the doors and take out the shelf, so as to prevent children's ingoing and probably subsequent door-closing, thus to avoid any possible injury to them.

16. Only one type of energy is allowed to be used when it is on. It is strictly forbidden to run two power means together simultaneously. For instance, suppose your refrigerator is a three-way one, when it is powered by electricity, the other two sources must not be used at the same time.

CAUTION:

When system is running on gas, the kerosene tank as well as the burner should NEVER be in the slide way, both MUST be removed from the back of the refrigerator and be placed in another place.





They have similar special structure, as shown in the figure:

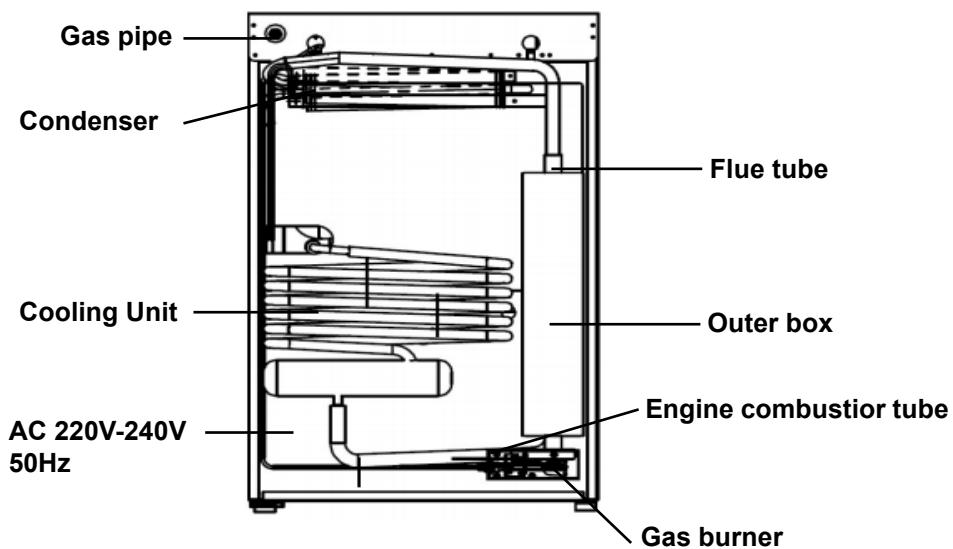

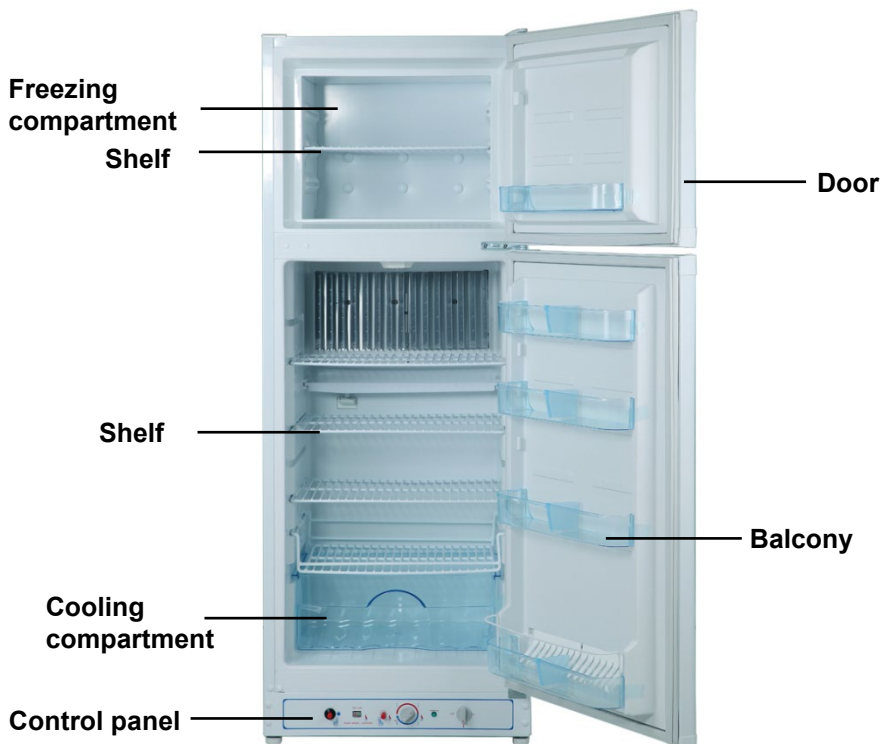

INSTALLATION INSTRUCTIONS

It is advisable to clean the inside of the absorption refrigerator with lukewarm water using a mild detergent, and then to dry it thoroughly prior to use. The refrigerator must be placed in a ground that is firm and flat. Make sure it is in the same level position from the aspects of four directions. All the four adjustable bottom screws should directly stand on the ground. It is highly suggested that you ask a qualified technician to help install the refrigerator, or the cooling effect may be impaired. For the clearance between the appliance and its surrounding, refer to the picture (The dimensions marked are minimum)

When you want to use the unit in an automobile, please turn to the distributor and ask them to install for you.

The gas system of our refrigerator is LPG.

It can't be operated before all its connections have been tested and confirmed to be safe.

For gas powered unit, it should be put in a place where it is convenient to repair the gas setup at the back of the refrigerator.

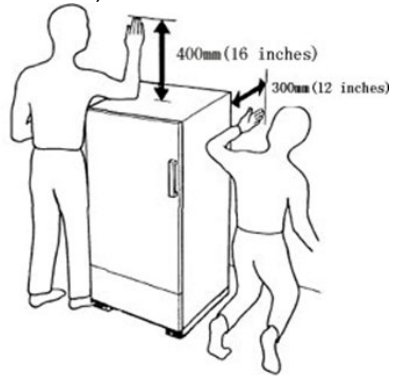

The clearance between the gas bottle and refrigerator should be no less than 1 meter.

LEVELLING AND VENTILATION

The refrigeration system of the cabinet is designed to operate with the cabinet located on a flat surface. Avoid tilting the cabinet side. If the cabinet must be tilted on an angle for handling or moving purposes, allow it to sit in an upright position 20 to 30 minutes prior to plugging it in and starting the cooling of the storage compartment.

Grounding plug and socket should be provided in accordance with local regulations. The cable-size should meet the refrigerator's requirements. The unit must be connected to proper electrical network, which is shown on the nameplate, through an omni poplar circuit-breaker. To assure the proper function of the refrigerator, please observe the following recommended.

To ensure the circulation, the unit should be kept at 400 mm, away from the rear wall and possible side walls. The clearance above the refrigerator should be at least 300 mm.

Locate the unit away from direct sunlight. This will enable you to obtain the best performance and save energy. Further the room should have a window (which can be opened) or a door to the outside.

It is important that the refrigerator is not subject to radiation of heat from a stove etc.

For best performance also at high ambient temperatures there must be a free air circulation over the cooling unit at the rear of the refrigerator. The refrigerator is designed for a free-standing installation.

GAS CONNECTION

The refrigerator is designed for operation on LPG gas, Check that this is stated on the data plate. The refrigerator is NOT designed for operation on town gas or natural gas.

Only use a regulator comply with the requirements of EN16129 or EN12864 and, comply with local code; Use hose comply with the requirement of BS3212 and complying with local code, The hose length cannot exceed 1.5 meters . Hose cannot be folded, twisted; We suggest that replaced the hose every year or at least in the expire dated of the hose. Replace a new hose in case of blockage or leakage was found.

CAUTION!

CHECK THAT THE GAS SUPPLIED TO THE REFRIGERATOR IS AT THE PROPER PRESSURE. SEE THE PRESSURE REGULATOR ON THE GAS CONTAINER.

We suggest using 15 kilograms below (with a maximum cylinder diameter: 320mm) liquefied petroleum gas cylinders, The clearance between the gas bottle and refrigerator should be no less than 1 meter.

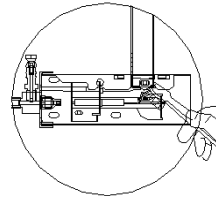

This appliance shall be installed only by authorised persons and in accordance with the manufacturer's installation instructions, local gas fitting regulations, municipal building codes,

The gas supply pipe should be connected to the gas inlet of the gas control valve by means of a suitable threaded coupling.

In making the connection to the refrigerator, a union gas cock of an approved bottled-gas type must be incorporated in the supply line in a position which is readily accessible to the user. For eventual servicing purposes, the union should be on the outlet side of the cock and the pipework should be positioned so as not to prevent the refrigerator from being readily withdrawn.

Turning On The Refrigerator

1. Turn on the gas supply from the gas cylinder.
2. Push and turn the burner control knob to the full open position.
3. Keep hold in the control knob, press down the ignition device button to light the burner.
4. Observe the burner flame and hold on the control knob for further 10~15 second.

The refrigerator is fitted with a flame supervision valve which is without manually shut off function.

AN APPROVED MANUAL SHUT-OFF VALVE MUST BE INSTALLED AT THE GAS INLET OF THE REFRIGERATOR. THE SHUT-OFF VALVE MUST BE ACCESSIBLE TO THE USER WHEN THE APPLIANCE IS IN THE INSTALLED POSITION.

BEFORE LEAVING –Check all connections for gas leaks with soap and water. DO NOT use a naked flame for detecting leaks. Ignite the burner to ensure correct operation of gas valve, burner and ignition. Turn gas tap to low flame position and observe stability of the flame. When satisfied, please instruct the user on the correct method of operation. In case the appliance fails to operate correctly after all checks have been carried out, refer to the authorised service provider in your area.

Turning Off The Refrigerator

If the refrigerator is not to be used for some time:

1. Shut off any valve in the gas line to the refrigerator.
2. Empty the refrigerator. Defrost and clean it as described in the following paragraph. It must be completely dry inside to avoid mold growth (if possible have the door open).
3. Set the thermostat button to the minimum position;

MAINTENANCE

Inspect the gas hose periodically for cracks or deep chafing marks. Connections can be tested for leaks using a soap solution.

We suggest that to be checked every month.

Never check gas leaks with an open flame. Use an approved leak-detection solution.

Cleaning the burner

Take off the protection hood and do the following:

1. Clean the openings and the burner screen with a toothbrush;
2. Clean and inspect the electrode and thermocouple. If either is corroded, have it changed. Check that they are well attached and if necessary tighten the screws;
3. Check that the spark is created by pressing the electric piezo ignite button on the control panel.
4. Do not use thin objects to either clean or unblock the injector.

Inside Lighting (Not available in every model)

Upon opening the door, the light is Turned on. The light operates with 4 batteries, 1.5volts AAA size each.

To change the batteries, use following procedure:

Batteries are mounted on the back of the refrigerator.

You need to replace the batteries periodically in case that the lamp is not bright enough.

To change the light bulb, Remove the plastic cap from the illumination container, replace the light as suggested.

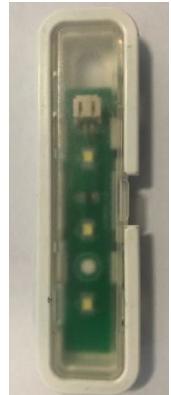

LPG powered Absorption-Diffusion refrigerators

SAFETY AWARENESS

On its initial use, you should inspect the tightness of all valve connecting pipes. Turn on the gas bottle valve (NOTE: Do not ignite the flame), check all completed connections for leaks with soapy water. Only after confirmation for security can you go on with further operation.

1. When you smell gas leak during operation, the steps below must be followed:

- a) Shut off the general valve of gas bottle
- b) Don't use any electric appliance including telephone
- c) Open the windows immediately for air flow
- d) Extinguish open flame around
- e) Contact the local supplier for troubleshooting. You are forbidden to use the unit before the trouble is solved.

2. When you use LPG to operate the refrigerator, we suggest that you install an exhaust pipe linked to the outside of the room, otherwise, there is a hazard of CO poisoning.

3. Never put the refrigerator in bedroom when it is LPG powered.

4. Do not touch the back of the unit while it is in use.

5. There should not be flammable materials or exploders heaping up in the vicinity of the appliance.

6. You must obey local regulations and laws concerning gas equipment. Be sure your gas type complies with that of your local place. Never allow kids or the unintelligent who have no custodian to operate the gas burner setup. For personal life and property security, do not let a child to run the appliance.

7. The passing LPG pressure of the valve is 28-30mbar.

You must immediately shut off the unit whenever you found a gas leak.

User instruction of Electric refrigerator and Gas refrigerator

1 Electricity powered Absorption-Diffusion refrigerators.

- 1) A refrigerator which can be electrically powered should be put in a level ground in the room. Ensure enough clearance between the refrigerator and the wall for the convenience of removing its packages. After all the packages are moved away, the interior of the appliance should be cleaned with soft cleanser and fresh water. (Regulate the thermostat knob to be the biggest if there is one)
- 2) Make sure that the voltage indicated complies with your local standard, and check whether the wire specification in the room meets the requirements of the refrigerator.
- 3) The refrigerator is equipped with a three-pin plug, when using electricity, be sure that the receptacle you will use is reliably grounded. The plug should be inserted directly into a properly grounded socket. Do not remove the ground pin contained in the plug.
- 4) To shut off the power, do not drag the power wire rudely. You should hold the plug head and plug it out cautiously and levelly.
- 5) If you find any damage on the wire, you must repair or replace it immediately. Cracked or ruptured wire, plug or connection points must not be used.
- 6) Never use a reorganized plug or a wire prolonged by yourself.
- 7) When it needs cleaning or servicing, the power of the refrigerator must be shut off. (Notice: Whenever your refrigerator needs maintenance due to any reason, we highly suggest you ask a qualified technician to do so)
- 8) When it is electricity-powered, it can't be operated in a bathroom or beside a swimming pool.
- 9) Kids or the unintelligent are not allowed operate the electricity system. Never let a child operate the unit.
- 10) If you feel a light numbness when touching some metal parts of the unit body, you should immediately pull out the plug, and have it examined to find out the possible causes. Do not continue to operate while there is an electricity leak.

PART A Installation and operation instructions for 220~240V powered refrigerators

The required voltage for the refrigerator that runs on only one voltage is 220~240V AC; while the voltages for the refrigerator that runs on two voltages are 220~240V AC. Confirm the voltage you will use complies with that of the refrigerator to ensure correct operation. The plug of 220~240V AC is equipped with a three-pin plug. When using electricity, be sure that the receptacle you will use is reliably grounded. The plug should be inserted directly into a properly grounded socket. Do not remove the ground pin contained in the plug.

How to start up 220~240V(50Hz/60Hz) AC powered refrigerators.

To start up 220~240V(50HZ~60HZ) AC powered refrigerator, plug in the power cord to the 220~240V AC supply receptacle, press on the electricity power button, and your refrigerator starts to run.

How to shut off 220~240V(50HZ~60HZ) AC powered refrigerators.

To shut off 220~240V(50HZ~60HZ) AC powered refrigerator, press down the power button to cut off power supply. Pull out the plug.

Temperature Control



1, the setting temperature range inside the refrigerator is 0 °C to 14 °C. You can turn the thermostat knob to get the temperature you want. Turn the knob clockwise, you can get lower temperature. Turn the thermostat knob counterclockwise to "OFF" position, the refrigerator will stop working.

2, the setting temperature range inside the foam door refrigerator is 0 °C to 10 °C

3 the setting temperature range inside the glass door refrigerator is 5 °C to 14 °C

PART A Installation and operation instructions for DC12V powered refrigerators

Do not use with another energy source.

Connect the 12V plug to the socket at the back of the appliance and to the car cigarette-lighter. Do not operate the appliance on a car battery on a stationary car as there is a risk of discharging the battery to the extent of making it impossible to start the car up again.

There is no thermostat temperature control while the appliance is charged by the battery.

PART A Installation and operation instructions of LPG powered refrigerators

The unit should be put in a level and firm ground in a well-ventilated room. Ensure enough clearances between the refrigerator and its surrounding. It is advisable to connect the flue tube with a suitable soft metal tube, in order to expel the exhaust smoke possibly caused during running to the outside of the room.

How to shut up LPG powered refrigerators.

a) Press down the knob(GAS) (Refer to the picture) for some time, and then press the ignition button, you may hear a sound “ka” that is, the piezo ignitor begins to ignite, and the gas line has been open.

b) A sound “peng” indicates the gas has been lit. For a refrigerator with a flame indicator, you can see the indicator is swaying, which also indicates the gas has been lit. Even after the flame has been lit, you should press the button continually for 10 seconds or so, then loosen your hands lightly. If the flame still can't be lit, you should repeat the above steps.

c) At the first ignition, or in the case that you restart your refrigerator after a long-period's shut-off, air may be present in the gas lines. In this case, you should repeat the ignition action until the air in the gas lines has been completely expelled, so that gas could reach the burner.

d) After the flame is lit, observe whether its position is correct. When the burning becomes steady, you can adjust the pressure regulators equipped on the gas pipes and the gas bottle. Let the pressure be a proper one (28-30mbar) in order to save energy. Your refrigerator starts to work.

How to shut off LPG powered refrigerators.

To shut off the refrigerator, turn off the general valve of the gas. The flame may not be extinguished at this time, because the refrigerator is fitted with a flame supervision valve which is without manually shut off function. AN APPROVED MANUAL SHUT-OFF VALVE MUST BE INSTALLED AT THE GAS INLET OF THE REFRIGERATOR. THE SHUT-OFF VALVE MUST BE ACCESSIBLE TO THE USER WHEN THE APPLIANCE IS IN THE INSTALLED POSITION. You can turn off the shut off valve or turn off the gas cylinder valve.

Suppose you won't use the unit for a long period, please turn off and move away the gas cylinder connected to the appliance.

For LPG refrigerators, we equip fire-extinguishing safety setup, when the flame is off due to wind or other causes, the safety component itself will be able to shut off the gas lines within 20 seconds. In that case, if you want to restart your refrigerator, you should repeat the action of ignition; if not, you should shut off the general gas supply in the gas cylinder valve.

How to change a new gas bottle

Suppose you find the cooling effect of your unit is not as good as before after a certain period, inspect whether there is still gas pressure, if not, shut off the gas cylinder valve, move away the gas cylinder connected to the appliance, change for a new gas bottle, and you can restart your refrigerator now(Refer to section “How to start up LPG powered refrigerator”)

Warning: The gas container shall be changed in a position that away from any source of ignition

The refrigerator is designed with 3 optional ignition functions, one is battery ignition function, the other is piezo ignition function.

Battery ignition

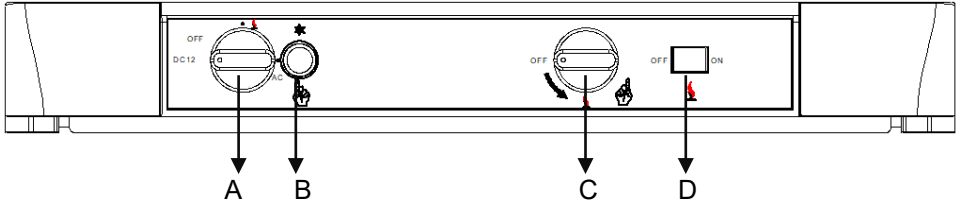

- A: Rotary switch; B: Battery switch C: Safety valve button/knob ;
D: Flame indicator;

1: Use the refrigerator (pulse ignition)

1): When the user uses the refrigerator, when the gas energy source is selected, the gas connection hose is fixed and sealed.

2): Select the gas position at the "A" switch.

3): Keep safety valve C pressed, turn it to the maximum flame  , hold it down for about 10 seconds to purge the air in the pipeline.

4): Then press "B" until the pointer at "F" turns from the red area to the green area. At this time, press and hold the "C" key for 10-15 seconds, it can be released, and the refrigerator can be used.

1.1: Turn off the refrigerator:

1): When not using the refrigerator, the valve on the gas cylinder can be directly closed. Make sure it is tight.

2): The "A" switch selects the "OFF" position, the "F" flame indicator changes from the green area to the red area, and the flame is turned off.

2:220-240V Operation:

1): When using the refrigerator, when using the AC 220-240V energy source, make sure that the power plug is connected to the outlet.

2): Select the AC gear position at the "A" switch, and the power is turned on.

3:DC12V Operation:

1): When using the refrigerator, when using the DC12V energy source, make sure that the power plug is connected to the outlet.

2): Select the DC12V gear position at the "A" switch, and the power is turned on.

4.1: Turn off the refrigerator:

- 1): When not using the refrigerator, you can directly unplug the AC power plug.
- 2): The "OFF" position is selected by the "A" switch.

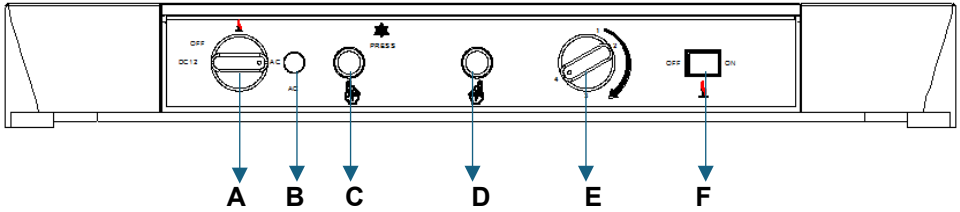

A: Rotary switch; B: Power on light; C: Battery switch
D: Safety valve button E: Thermostat knob; F: Flame indicator;

1: Use the refrigerator (pulse ignition)

- 1): When the user uses the refrigerator, when the gas energy source is selected, the gas connection hose is fixed and sealed.
- 2): Select the gas position at the "A" switch.
- 3): Press "D" for 30 seconds to empty the air in the pipeline.
- 4): Then press "C" until the pointer at "F" turns from the red area to the green area. At this time, press and hold the "C" key for 10-15 seconds, it can be released, and the refrigerator can be used.

1.1: Turn off the refrigerator:

- 1): When not using the refrigerator, the valve on the gas cylinder can be directly closed. Make sure it is tight.
- 2): The "A" switch selects the "OFF" position, the "F" flame indicator changes from the green area to the red area, and the flame is turned off.

2: 220-240V Operation:

- 1): When using the refrigerator, when using the AC 220-240V energy source, make sure that the power plug is connected to the outlet.
- 2): Select the AC gear position at the "A" switch, the indicator light at "B" lights up, and the power is turned on.

3: DC12V Operation:

- 1): When using the refrigerator, when using the DC12V energy source, make sure that the power plug is connected to the outlet.
- 2): Select the DC12V gear position at the "A" switch, and the power is turned on.

4.1: Turn off the refrigerator:

- 1): When not using the refrigerator, you can directly unplug the AC power plug.
 - 2): The "OFF" position is selected by the "A" switch.
- If the refrigerator is not used for a long time, it should be emptied and defrosted.

Clean the refrigerator and make sure the refrigerator door is open.

Piezo ignitor

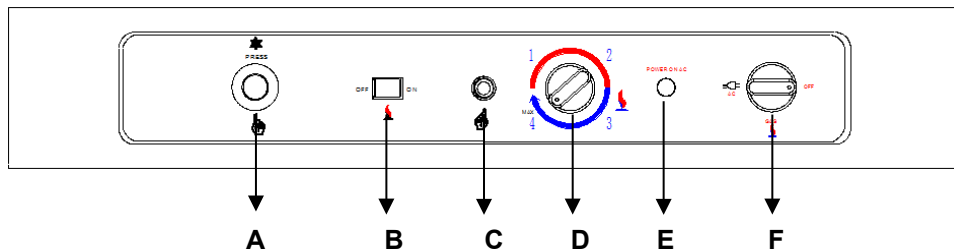

A: Piezo ignitor; B: Flame indicator; C: Safety valve button;
D: Thermostat knob; E: Power on light; F: Rotary switch

1: Use the refrigerator (piezo electric ignition)

1): When the user uses the refrigerator, make sure that the gas connection hose is firmly sealed.

2): Press "C" for 15 seconds to empty the air in the pipeline.

3): Then press "A" continuously until there is a frequency until the pointer at "B" turns from the red area to the green area. At this time, press and hold the "C" key for 10-15 seconds, you can release it and the refrigerator can be used.

1.1: Turn off the refrigerator:

1): When not using the refrigerator, the valve on the gas cylinder can be directly closed. Make sure it is tight.

2): The "G" switch selects the "OFF" position, the "C" flame indicator changes from the green area to the red area, and the flame is turned off.

2:220-240V Operation:

1): When using the refrigerator, when using the AC 220-240V energy source, make sure that the power plug is connected to the outlet.

2): Select the AC gear position at the "A" switch, the indicator light at "B" lights up, and the power is turned on.

2.1: Turn off the refrigerator:

1): When not using the refrigerator, you can directly unplug the AC power plug.

2): The "OFF" position is selected by the "A" switch.

If the refrigerator is not used for a long time, it should be emptied and defrosted. Clean the refrigerator and make sure the refrigerator door is open.

Please use the above methods according to the configuration of the user's purchased products.

If the burner has not lit after 4-5 attempts, turn off the gas tap, wait 5 minutes and then try to re-light. If the burner still fails to light, please contact the authorised service provider in your area.

Note: If the battery ignition fails to spark, you might need to replace the battery

Instructions of thermostat (An optional component and its use)

Thermostat is an optional component, its function is to reduce energy needs and keep the temperature in compartment steady. The thermostat is an option for the refrigerator depending on customer's demand. We have electricity thermostat for 220~240V powered refrigerators and gas & electricity thermostat for gas & electricity powered refrigerators.

DC12V There is no thermostat temperature control while the appliance is charged by the battery.

Users, depending on their own need, can adjust the internal temperature. The refrigerator with a thermostat is settled at the "middle" setting before it goes out of the factory. Users can adjust the internal temperature according to their own need as well as changes of climate and ambient temperature.

How to adjust temperature with electricity thermostat

Before the finish unit goes out of the factory, its electricity thermostat has been settled in a proper position. Depending on the foods you store, regulate an appropriate position of the knob, which can save energy. Turn the knob according to the marked direction to make the internal temperature either higher or lower.

PART B Care and maintenance for electricity powered refrigerators.

The energy for cooling system of absorption refrigerator sources from an electric heater, which is an embedded heating system.

If 220~240V(50Hz/60Hz) AC heater needs replacement, first, disconnect the power cord of the refrigerator from 220~240V power supply. The heater can be changed as follows:

- First, make sure that you don't operate this system until it has cooled down
- a) Plug the power cord out of the supply socket, dismantle the heater's wiring on the terminal;
 - b) Loosen the cover outside the heater;
 - c) Remove insulation wool so that the heater is accessible;
 - d) Turn and lift the heater out of its pocket;
 - e) Install the new heater into the pocket, connect the power cord to the terminal;
 - f) Carefully put the insulation wool back into the initial position and close the cover outside the heater;
 - g) Test and confirm there is no power leak to ensure the unit security;
 - h) Start up the refrigerator to see whether it can normally work (refer to section "how to start up electricity powered refrigerator")
- (Qualified technician only)**

V Regular care and maintenance

Notice: before operating the unit, you should confirm what energy source it uses. If electricity, make clear about the voltage it demanded. The voltage of our products is 220V~240V (the running won't be influenced by the change range from 220V to 240V).

Changing the heating element

The heater which is fitted inside the boiler casing (B), of the refrigerator unit, can be changed as follows:

1. Pull the power cord out of the wall socket.
2. Remove the cover C.
3. Remove some insulation wool so that the heater A is accessible.
4. Open the terminal block cover and disconnect the heater leads.
5. Turn and lift the heater out of its pocket.
6. Fit the new heater into the pocket.
7. Connect the leads and close the terminal block cover.
8. Carefully put the insulation wool back into position and close the cover of the boiler casing.

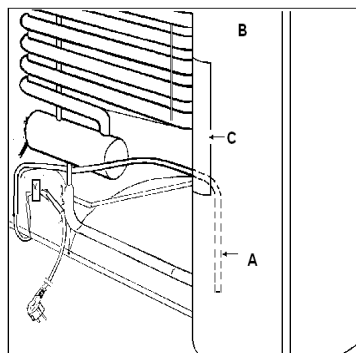

PART B Care and maintenance for LPG burner

a) When igniting, press the button of gas valve, meanwhile, press the pressing ignitor, you may hear a sound of “ka” the ignitor pin has started to ignite, if the spark can't gather in the center or it is too far from the gas hole of the burner, the gas from the burning hole can't be lit. In that case, you should adjust the position of the ignition pin. Procedure: Loosen the two butterfly-shaped holder screws beside the burner, adjust the ignition pin to a proper position. A clearance of 2-3mm between the pin and the burning hole would be appropriate. Always keep the ignition pin clean.

b) While the burner is in use, you should clean and adjust it periodically (10 days is advisable). Before cleaning, you must first shut off the gas supply and wait until it cools down. Uninstall the burner, with a soft brush, clean the dust on the burner head. The gas-in hole can also be blown by means of compressed air, or wiped with spirits. However, you are absolutely not allowed to unclog the jet hole or gas line central hole with a needle or needle-like materials, because this will result in either blocking or enlarging the jet hole. Under the former circumstance, the gas may be restricted; under the latter circumstance, the jet hole will be enlarged, resulting in heavy flame and consequently a waste of energy, and so on. We suggest you clean and adjust the burner whenever you change the gas bottle.

c) If the LPG used is of poor quality, there will be accumulated thick dust and soot in the interior of the flue, you should do cleaning work at regular intervals with a brush. You can purchase the brush from the distributor.

d) When the burner is too old(2-3 years) to continually run, turn to the distributor and purchase a new set of burner and ask the distributor or a serviceman from a service center to reinstall it for you.

Note: If the battery ignition fails to spark, you might need to replace the battery.
(Qualified technician only)
Care and maintenance for LPG powered refrigerator.

Correct operation of refrigerators.

When initiate to use the refrigerator, you should clean its interior. Fresh water is suitable.

Cooling compartment:

Cooling compartment is used to store fresh foods. Generally, its temperature ranges from 0°C to 10°C.

This compartment is completely closed and not ventilated, for that it must keep a reasonable temperature for storing foods. Therefore, it is best to cover the foods that have peculiar smell or those easily absorb other smells. Store the vegetable and salad with a covered container. The coldest position lie in the vicinity of evaporator and the bottom of the refrigerator; the sub-coldest position lies in the top of the door. Take all these factors into consideration when you are storing different foods.

Freezing compartment:

Freezing compartment is used to store frozen foods. Its temperature is below -6°C. The freezing compartment is not designed for prompt freezing, it is just used to store frozen foods. In order to prevent food from air-dry, please reserve the foods with covered boxes, plastic bags and aluminium membrane. For fast freezing of soft foods and ice cream, you should put them in the coldest position in the freezer, that is, in the vicinity of evaporator cooling fins.

Ice-making

For fastest ice-making, the ice-form should be placed directly on the evaporator in the freezing compartment. The water should project 5mm to the top of the ice-form.

A fridge without a freezing compartment can also fulfill ice-making. The water should project 5mm to the top of the ice-form and be put on the evaporator. The manufacturer doesn't equip the ice-form. Purchase one from the distributor.

Defrost:

Shut off the power of refrigerator (refer to section "How to shut off the refrigerator" take out the foods, open the doors, wipe the water in the compartment after the frost on the evaporator completely melt.

Clean brush

Remove the burner top

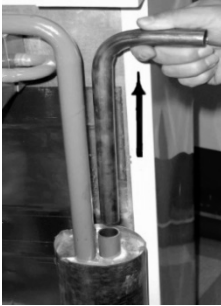

Clean the flue by brush



Replace the baffle



Examine the soot flue on the refrigerator. Be sure there is no soot and keep the flue clean. If there is heavy soot in the flue, the burning efficiency would be impaired. Thus, with the special brush supplied, you should clean the soot regularly (refer to the picture)

Make sure that you don't operate this system until it has cooled down. It is recommended to check the gas leaks at reasonable intervals (two weeks or so) after installation of gas refrigerator. With soapy water, check all of the pipe connections. All the checks must be carried out when there is no open flame.

At least, you should inspect your refrigerator clean. Let the unit be far away from flammable materials, gasoline as well as other combustible vapor and liquid. It is advisable to do frequent inspection for ventilation system for good air flow

Any of the servicing for gas refrigerator, including above mentioned replacement, maintenance as well as the tidying and cleaning work and so on, should be done under instructions of the distributor or a qualified serviceman from a specialized service center.

Reasons for not cooling and corresponding remedies(Should be done by a qualified service man)

1. Gas Operation Failure

- a. Once the burner jet clogged, unscrew and wash with alcohol or vapors. Do not unclog the jet with iron wire or needle-like materials;
- b. Make sure the unit is put in level position;
- c. Confirm the flame is still on;
- d. Check whether the air around ventilates well;
- e. In case there is thick frost on the evaporator and cooling-dissipating plate, shut off the power, open the refrigerator door and defrost it;
- f. If the LP gas pressure is not high enough, change the gas bottle in time;
- g. The gas burner should be changed if damaged;

Reasons for odor of gas and relevant solutions:

Whenever you smell odor in the room, you should check immediately:

1. The improper installation of burner may lead to the flame's burning on the heat-wall, relocate it; incorrect installation of the burner may also cause heavy smoke and discolor the warm-keeping cover even the whole unit.

2. The burner should be changed if damaged;

3. If the flue is too short, extend it with a soft thin metal tube linked to the outside of the room.

4. If the interior of the flue is too dirty, clean with the special brush supplied.

5. In case the gas or kerosene being used proves to be of poor-quality, substitute with good quality type.

REMINDER:

We are very grateful that you choose Absorption-Diffusion multi-way refrigerator manufactured by our Company.

We assure you of reliable quality for our products, yet we do not hold responsibility for the trouble caused by improper installation or incorrect operation. If there is any more problem, you'd better contact the distributor or a service center for advice.

Correct Disposal of this product	
	This marking indicates that this product should not be disposed with other household wastes throughout the EU. To prevent possible harm to the environment or human health from uncontrolled waste disposal, recycle it responsibly to promote the sustainable reuse of material resources. To return your used device, please use the return and collection systems or contact the retailer where the product was purchased. They can take this product for environmental safe recycling.

TROUBLESHOOTING

Problem	Likely Cause	Solution
Refrigerator and/or Freezer are to warm	Is the burner lit	If the burner is not lit, re-light and check operation. If the burner does not light, refer to "Burner will not Light".
	Is it time to defrost	Defrost according to Owner's Manual.
	Is the gas pressure correct	Have a qualified technician check your gas pressure. i.e. local propane company. The gas pressure should be 11" water column.
	Is the ambient temperature extra warm	Limit door openings to absolute minimum.
	Are the condenser fins dirty	Clean the condenser fins.
	Are the absorber coils dirty	Clean the absorber coils.
	Do you smell ammonia	If there is an ammonia smell, the cooling unit is leaking and must be replaced.
	Check for frost on evaporator outlet tubing	Tip refrigerator forward to 10:00 position and hold it there for 5 seconds, or you can wait for 10-12 hours and refrigerator will quit by itself.
Is the refrigerator level	Level the refrigerator according to the Owner's Manual.	
Refrigerator compartment freezes my food	Is the burner modulating? (flame goes from "high" to "low" flame while someone else turns thermostat knob from "MAX" to "MINIMUM")	If flame does not modulate, it may be possible that the thermostat is defective. Contact your local Diamond dealer for further information and replacement.
	Refrigerator is located in an unheated area, or where the temperature is low	If the area where the refrigerator is below 50°F, you must either move the refrigerator to a heated area, or build a cover for the refrigerator.
	Thermostat knob is at a cold setting	Turn thermostat knob counterclockwise to the warmest position, and then turn it clockwise to setting "2".
Burner will not Light	Ignitor will not spark	Reconnect ignitor wire. Inspect that the spark electrode tip is not further from burner slots than 1/8"
	Ignitor wire may be shorting out	Inspect the ignitor wire for frays and tears, and if torn or frayed, call your local Diamond dealer to get a replacement.
	Is the peizo ignitor functioning	Operate the ignition more often when lighting. Push the button rapidly until the flame lights.
Ignitor sparks, but burner will not light or stay lit.	Thermocouple may be bad	If flame does not stay lit when you release the gas safety valve, replace the thermocouple.
	Is the gas pressure correct	Have a qualified technician check your gas pressure. i.e. local propane company. The gas pressure should be 11" water column.

Note:

Frost on evaporator tube will not occur when refrigerator has not been running for a period of time, or upon initial start-up. (first time refrigerator is lit)

Model	Injector (mm)	Nominal heat input (kW)		Total mass of refrigerant	Rated power input(W)
		I3P(30)	I3B/P(30) I3+(28-30/37)		
DSG-40B2*(A) TSG-40B2*(A) HSG-40B2*(A) DSG-40B2*(C) TSG-40B2*(C) HSG-40B2*(C)	∅0.23	0.16	0.2	R717, 70g	65
DSG-60B2*(A) TSG-60B2*(A) HSG-60B2*(A) DSG-60B2*(C) TSG-60B2*(C) HSG-60B2*(C)	∅0.25	0.19	0.25	R717, 80g	90
DSG-100D2*(A) TSG-100D2*(A) HSG-100D2*(A)	∅0.30	0.29	0.37	R717, 145g	150
Remark	* can can be A,E, A represent Australia. E represent European Union and UK. UK add suffix"-B0/B6"				
Rated voltage	AC 220V~240V/ DC 12V				
Rated frequency	50/60Hz				
Foaming agent	C ₅ H ₁₀				
DDG-170D2*(A) TDG-170D2*(A) HDG-170D2*(A)	∅0.33	0.3	0.4	R717, 200g	240
DDG-190D2*(A) TDG-190D2*(A) HDG-190D2*(A)	∅0.38	0.48	0.61	R717, 255g	300
DDG-210D2*(A) TDG-210D2*(A) HDG-210D2*(A)	∅0.38	0.48	0.61	R717, 255g	300
DDG-230D2*(A) TDG-230D2*(A) HDG-230D2*(A)	∅0.38	0.48	0.61	R717, 300g	300
DDG-280D2*(A) TDG-280D2*(A) HDG-280D2*(A)	∅0.38	0.48	0.61	R717, 300g	300
DSG-200D2*(A) TSG-200D2*(A) HSG-200D2*(A)	∅0.38	0.48	0.61	R717, 300g	300
DDG-390D2*(B) TDG-390D2*(B) HDG-390D2*(B)	∅0.40	0.46	0.55	R717, 300g	300
Remark	* can can be A,E, A represent Australia. E represent European Union and UK. UK add suffix"-B0/B6"				
Rated voltage	AC 220V~240V				
Rated frequency	50/60Hz				
Foaming agent	C ₅ H ₁₀				